

EXEMPLE DE INSTALARE

NOMENCLATURA

	Descriere
Vfas	Senzor de iesire
Kfs	Senzor cazan
Sext	Senzor de exterior
Mc	Unitate de control
Bc	Pompa de recirculare
Ss	Senzor temperatura boiler ACM
Ac	Boiler ACM
E26	Controller climatic
BT	Puffer

	Description
Btd	Puffer cu boiler ACM incorporat
Lago	Unitate de control LAGO OT +
TaD	Termostat de camera
VA	Vana anticondens termostata
Vm	Vana amestec ACM
Vs	Supara siguranta ACM
Vee	Vas expansiune ACM
Ve	Vas expansiune incalzire
R	Rezistenta electrica

	Description
Vr	Supapa de sens
Sbt	Senzor temperatura puffer
BBt	Pompa puffer
Tacs	Termostat boiler ACM
FBR2	Senzor de camera FBR2
TA	Termostat de ambient
TaD	Termostat de camera circuit direct
TaM	Termostat de camera circuit amestec



BIOCLASS HM SI KIT HIDRAULIC CU VANE DE AMESTEC TERMOSTATATE

KIT DMt

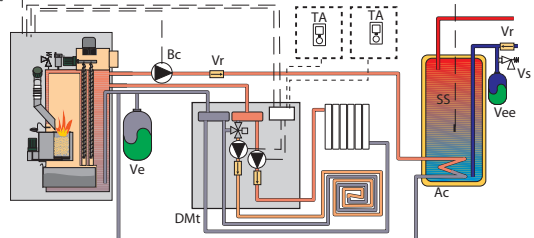

KIT Mt

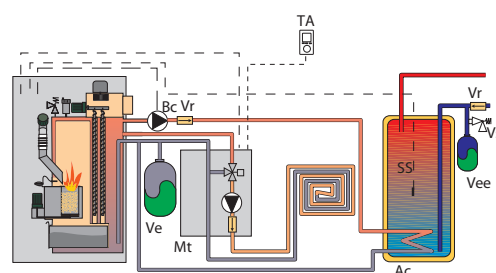

BIOCLASS HM CU KIT HIDRAULIC BIO SI SENZOR EXTERN

KIT BIO M

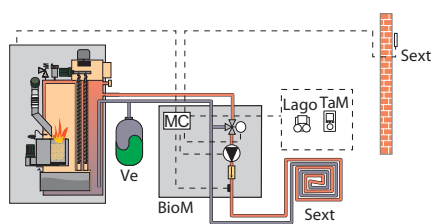

KIT BIO DM/MS

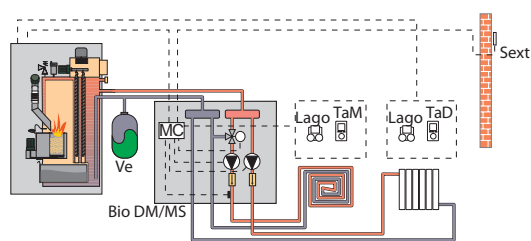

KIT BIO DM/MS

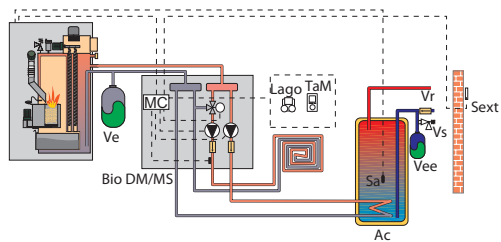

KIT BIO DMS

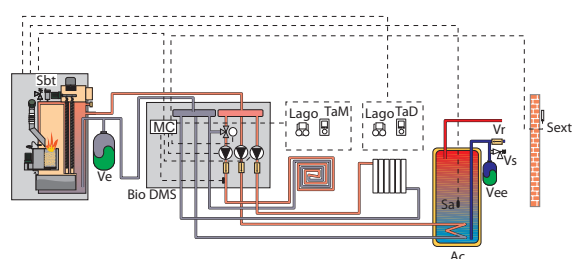

KIT BIO 2M

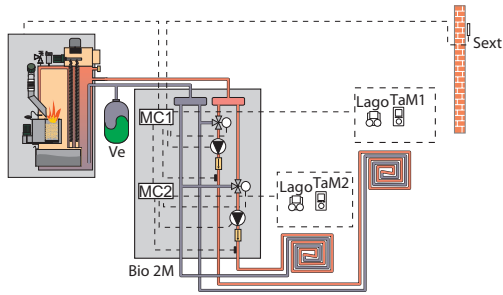

KIT BIO D2M/2MS

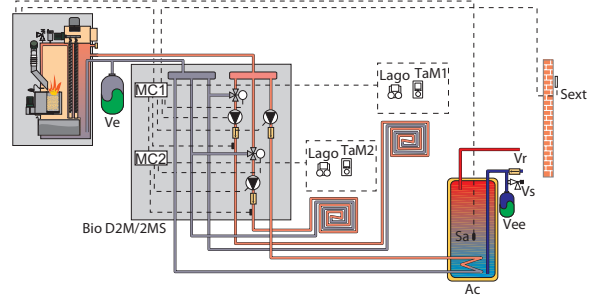

KIT BIO D2M/2MS

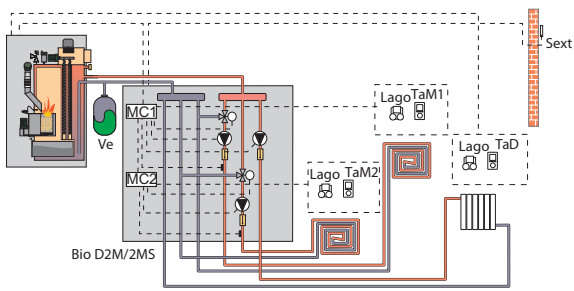

KIT BIO M + BT

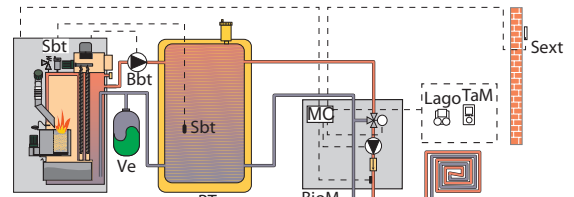

KIT BIO DM/MS + BT

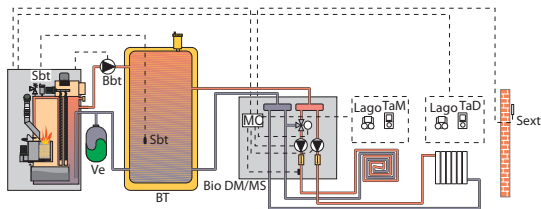

KIT BIO DM/MS + BT

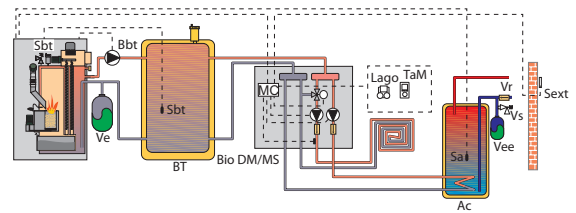

KIT BIO DMS + BT

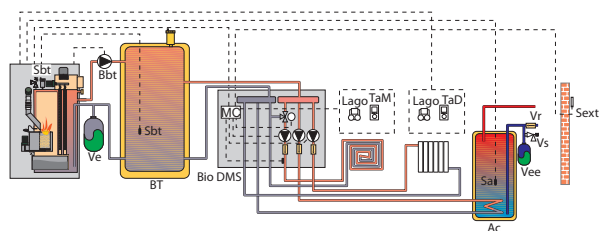

KIT BIO 2M + BT

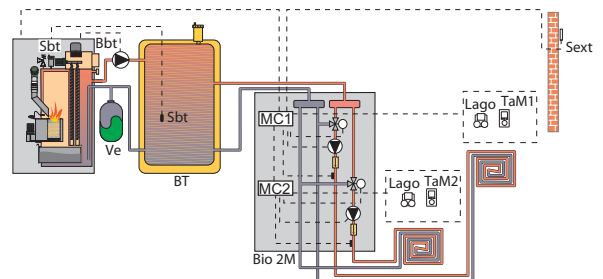



Circuit amestec



ACM



Circuit direct



Puffer cu boiler ACM incorporat



Puffer



Separator hidraulic

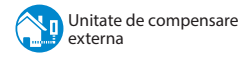

Unitate de compensare externa

KIT BIO D2M/2MS + BT

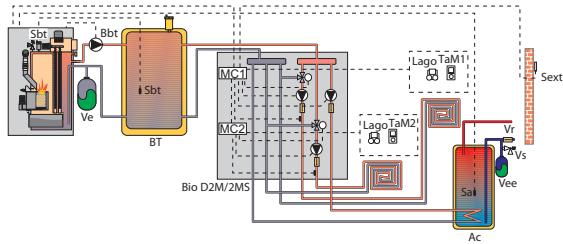

KIT BIO D2M/2MS + BT

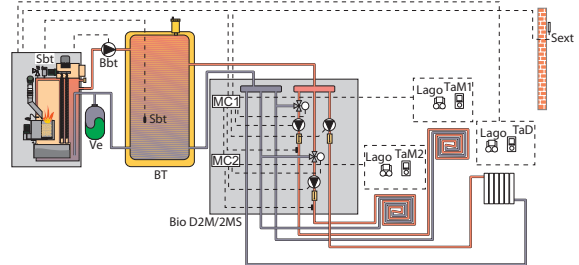

BIOCLASS HM CU KIT HIDRAULIC BIO SI SENZOR EXTERN

KIT BIO M + BT DUO

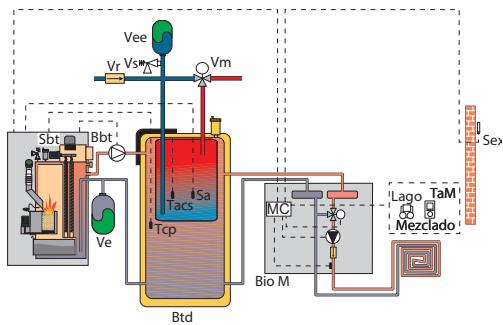

KIT BIO DM/MS+ BT DUO

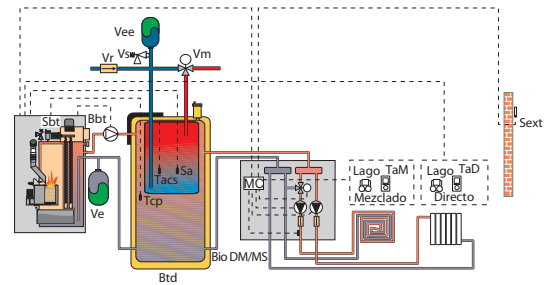

KIT BIO 2M + BT DUO

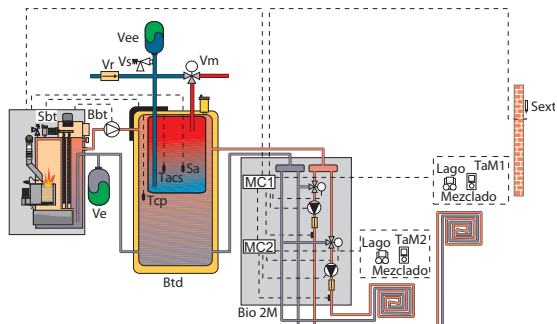

KIT BIO D2M / 2MS + BT DUO

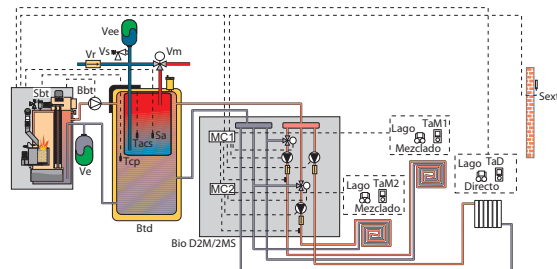

BIOCLASS HM CU PUFFER

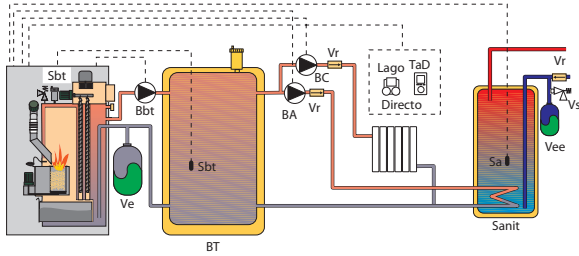

BIOCLASS SI PUFFER CU BOILER ACM INCORPORAT

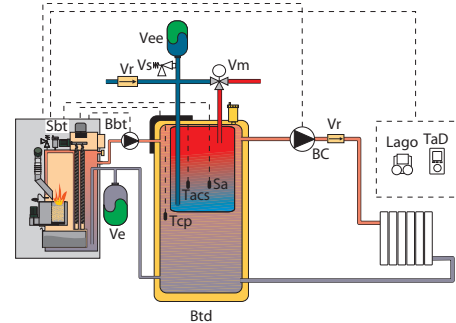

2 CENTRALE BIOCLASS INSTALATE IN CASCADA CU PUFFER

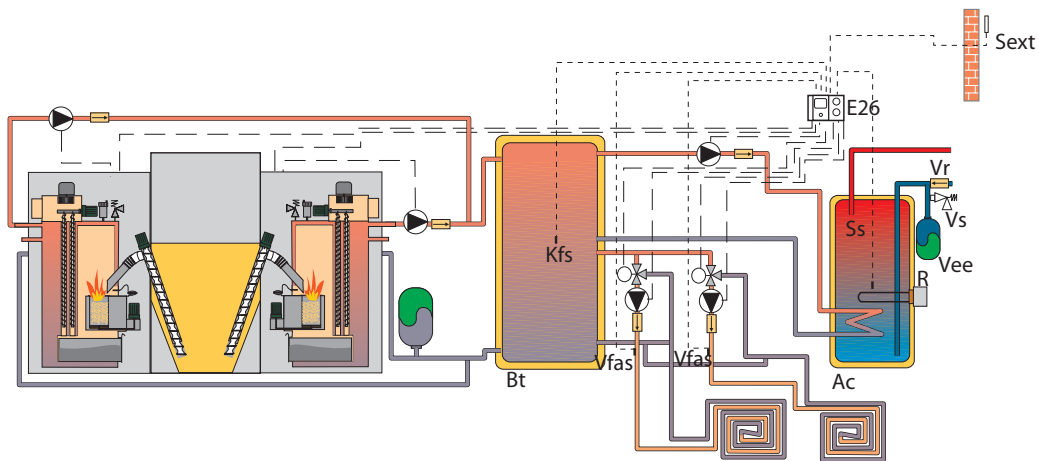

KITURI HIDRAULICE

Kit hidraulic Mt

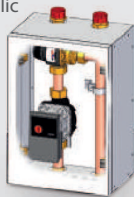

Kit hidraulic DMt

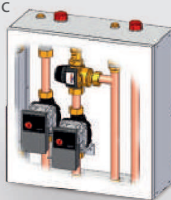

Kit hidraulic BIO M

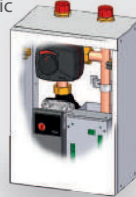

Kit hidraulic BIO DM/MS



Kit BIO DM



Kit BIO MS

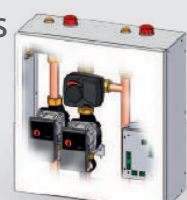

Kit hidraulic BIO 2M

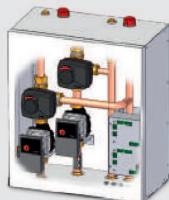

Kit hidraulic BIO D2M/2MS



KR BIO D2M



Kit BIO 2MS

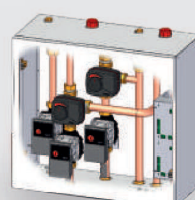

Kit hidraulic BIO DMS

